

# NYLON MOLDING CORPORATION

Division of NMC Group, Inc.

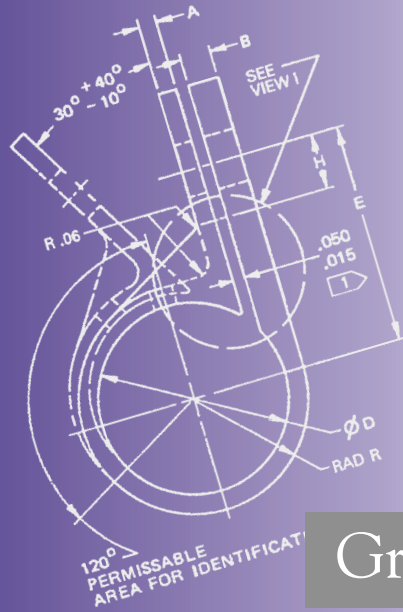

Clamps

Grommets

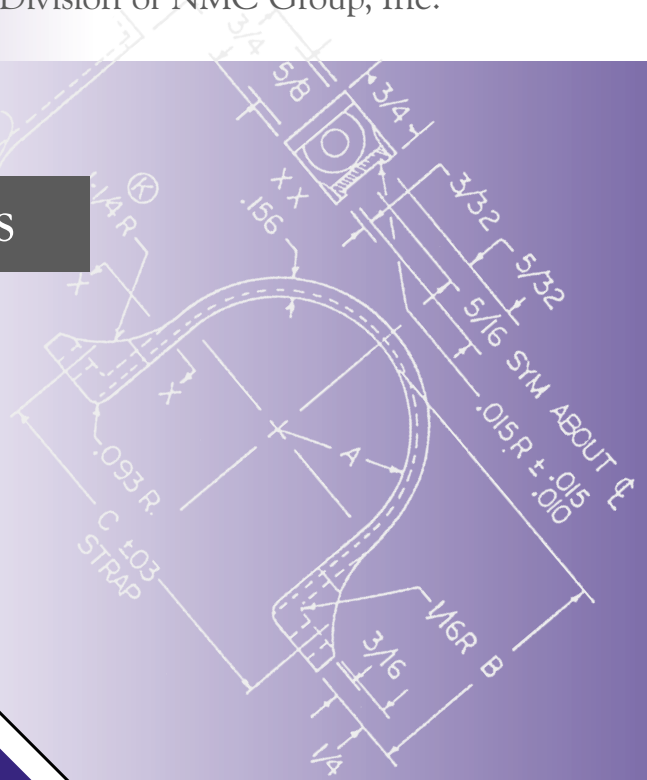

Misc. Plastic Parts

Custom Injection Molding

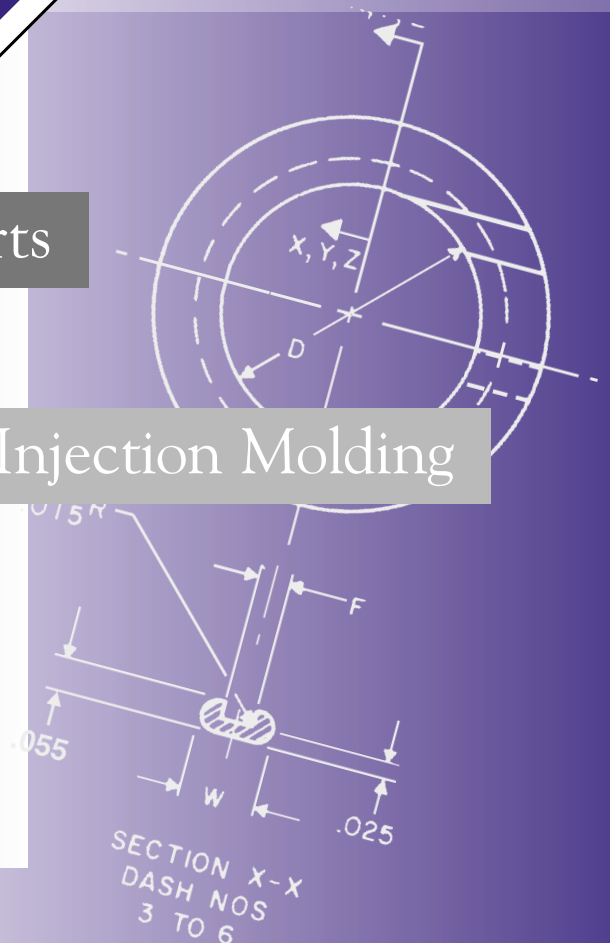

800-321-1243

[www.nmcgroup.com](http://www.nmcgroup.com)



**NMC**

Nylon Molding Corporation (NMC), is a quality supplier to a wide range of industries, from aircraft and electronics to medical and automotive. We offer a line of products that includes plastic clamps, grommets and wiring devices. In addition, we offer custom molded plastic parts for use in all major industries – aerospace, medical, electronics and consumer products.

- 50 YEARS OF INJECTION MOLDING EXPERIENCE
- TEAMWORK – YOU AND NMC
- SPC MANUFACTURING WITH A DISTRIBUTOR MENTALITY
- TOTAL COMMITMENT TO QUALITY
- SERVICE AND CONVENIENCE

For over 50 years, NMC has been committed to providing quality and customer satisfaction – we're dedicated to being your best source for your manufacturing needs.

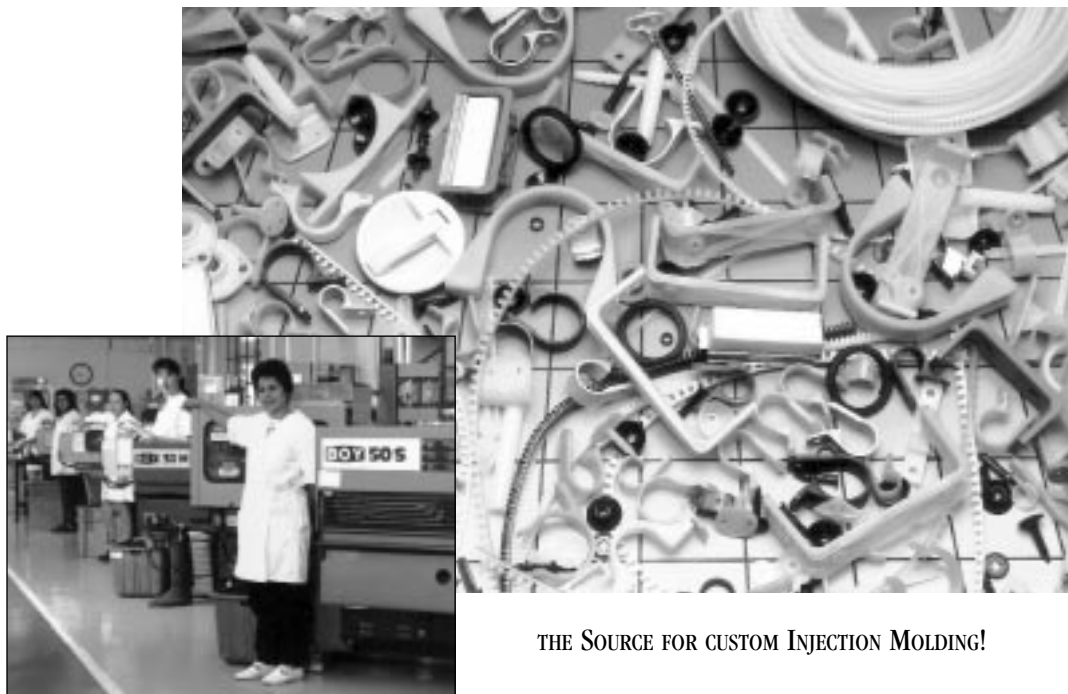

THE SOURCE FOR CUSTOM INJECTION MOLDING!

Call for data sheets and samples: 800-321-1243 • [www.nmcgroup.com](http://www.nmcgroup.com)

# Grommets

Nylon Molding Corporation (NMC) creator of the original Caterpillar Grommet has supplied aircraft, automotive, medical and electronic manufacturers with the highest quality grommets, support clamps, seals and cable ties for over fifty years. Our thorough product lines and responsive service have built a solid reputation throughout various industries.

## Split Plastic Grommet

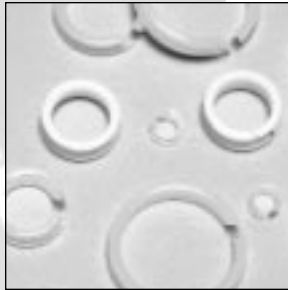

**NMC 557-(series)**  
NAS 557-(series)

## Split PTFE Grommet



**NMC GR1554-(series)**  
NAS 1554-(series)

## Flanged Hole Grommet

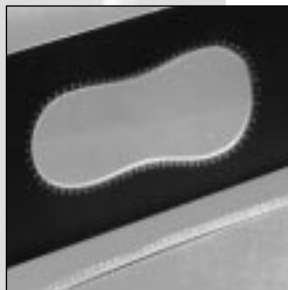

**NMC G24-(series)**  
BAC G20AD-(series)

## Caterpillar Grommet – Coil Form

**NMC G51-(series) x Length**  
BAC G20Z-(series)

## Caterpillar Grommet



**NMC G51-(series)**  
BAC G20Z-(series)  
MS 21266-(series)

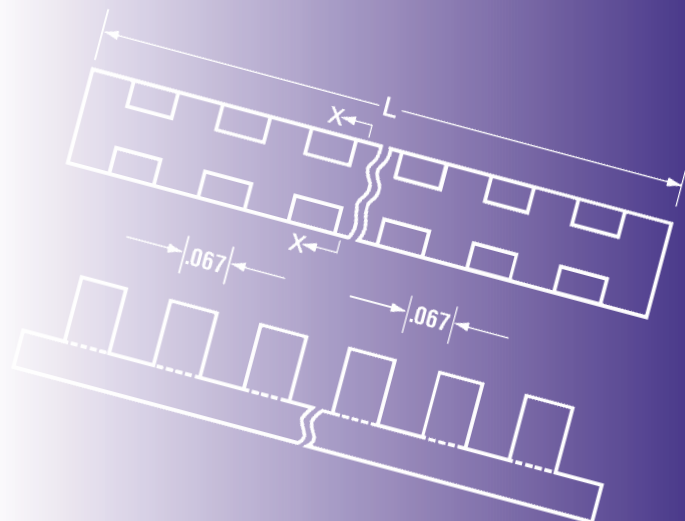



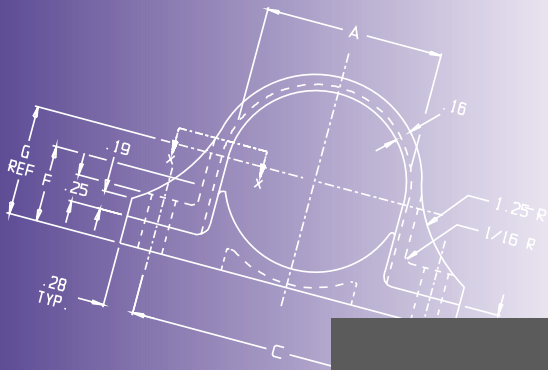

# Clamps

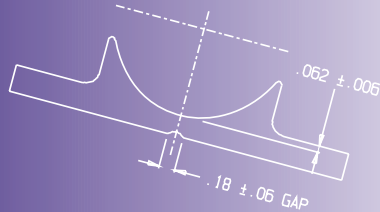

Nylon Molding Corporation supplies support clamps, adjustable clamps, clamps for wires, tube support clamps, raceways – and more. Applications include aircraft, marine, electronics and automotive industries. These clamps and raceways meet existing dimensions and current blueprints in the marketplace. Contact NMC for full engineering specifications.

**Adjustable Clamp 90°**



**NMC-1001-(series)**  
M23190/1-(series)

**Adjustable Clamp 30°**



**NMC CA2030-(series)**

**Tube Support Clamp**



**NMC S7701100-(series)**  
NAS 1787-(series)

**Tube Support Clamps**



**NMC CA7500-(series)**  
BAC C10EW (series)

**Clamp – Light Duty**



**NMC (XX) LN**  
**NMC (XX) HN**  
NAS 1397-P (series)

**Support Clamp Wiring**



**NMC CL141N-R (series)**  
MS 25281-R (series)

**Support Clamp**



**NMC 3650-(series)**  
MS 25281-F (series)

**Support Clamp, Flat Color Coded**

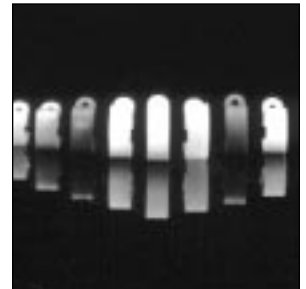

**NMC 3625-(series)**  
BAC C10DK (series)  
NSA 5515-(series)

# Misc. Plastic Parts

NMC is continually growing its product lines of:

- Insulation Fastening Products
- Standoff Fastening Devices
- Cable Tying Systems
- Other Miscellaneous Molded Items

Whenever plastic components are used within an air-frame, NMC has the capability of supplying those items. We also supply items where multiple plastic items such as coat hooks and hangers are molded and then assembled.

**Insulation Fasteners**



**NMC OP-(series)**  
BAC S21AG (series)

**Insulation Fasteners**



**NMC OP 1913-(series)**

**Insulation Fasteners**

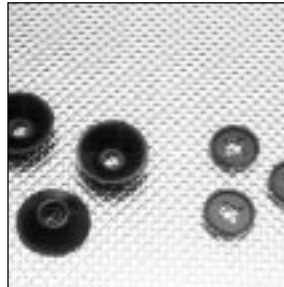

**NMC PW3A /PW4 /OP346-2**  
BAC C15AC (series)

**Seal, Bulkhead**



**NMC S45A-(series)**  
BAC S45A-(series)

**Stand-off Insulators  
Plastic**



**NMC 650/660/670-(series)**  
5D0029 / 5D0030 / 5D0031

**Stand-off Insulators  
Plastic**



**NMC STS & SNX-(series)**  
BAC N10TS (series)  
BAC N10NX (series)

**Standoff, Clip-on**

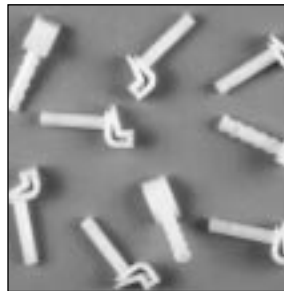

**NMC SC3360-(series)**  
9D0212-(series)

# NYLON MOLDING CORPORATION

Division of NMC Group, Inc.

**Snap Grommet (Plastic)**



**NMC 751118151**

**Sealing Plugs**

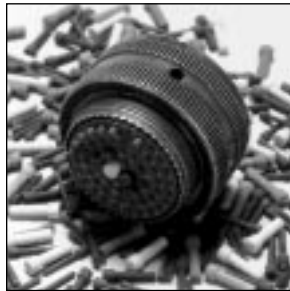

**MS 27488-(series)  
MS 3187-(series)**

**Coat Hooks & Latches**

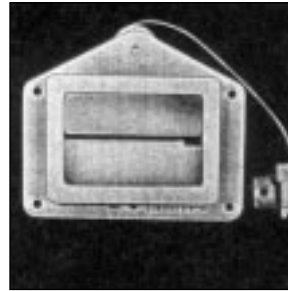

**Hanger Plastic**

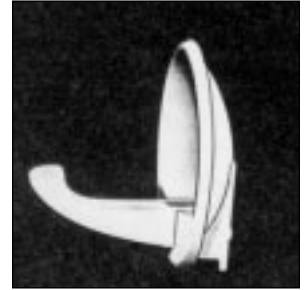

**Cable Tie**



**NMC (series)  
MS 3367-(series)  
MS 3368-(series)**

**Cable Tie Mounts**



**NMC**

**Clip Assembly Bracket**

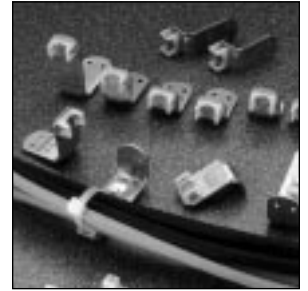

**NMC**

## Misc. Plastic Parts

NMC manufactures its own product line and/or can review your unique product application for manufacture. Our capabilities in molding, engineering and tool building can be great assets to your organization. We look forward to supporting your plastic part needs.

Other manufacturing services available:

- Sonic Welding
- Cutting/Drilling
- Eyeletting
- Insert Installation



Call for data sheets and samples: 800-321-1243 • [www.nmcgroup.com](http://www.nmcgroup.com)



# Custom Injection Molding

## INJECTION MOLDING

Machines range in size from 24 to 200-ton presses. Small to mid-size parts are NMC's specialty. We'll work with your part design in order to build the best tooling which meets your unique requirements.

## CAD/CAM

We utilize a CAD system to design products and molds.

## MOLD DESIGN AND CONSTRUCTION

In-house mold design and construction – mold maintenance and repair services available.

## QUALITY ASSURANCE SYSTEM

Approved by major aircraft, medical and automotive industries. These include:

MIL-I-45208A

MIL-Q-9858A

MIL-STD-45662

D1-9000 AQS for Boeing

Lockheed QCS 320 A & B Certified  
Process Monitoring Statistical Process Control



## NYLON MOLDING CORPORATION

Division of NMC Group, Inc.

2755 Thompson Creek Road • Pomona, CA 91767-1861

909.451-2290 • 800.321-1243

FAX: 909.593-8309 • [www.nmcgroup.com](http://www.nmcgroup.com)