

1. LAMPS: INCANDESCENT, SUBMINIATURE, T1, SUB-MIDGET FLANGED BASE
 - MS3338-6839, AGED AND SELECTED PER KORRY DWG 000-040-159 (28 VDC).
 - DL 71BAS15 (5 VDC)

2. BASE ASSEMBLY TO BE PART MARKED WITH THE FOLLOWING INFORMATION AS SHOWN: (LOCATION OPTIONAL)
 A) "TOP"
 B) "KORRY"
 C) SOURCE CODE
 D) DATE CODE
 E) KORRY BASE ASSEMBLY PART NUMBER
 F) KORRY SWITCH ASSEMBLY PART NUMBER (OMIT WHEN BASE IS ORDERED SEPARATELY)

3. CAP ASSEMBLY TO BE PART MARKED WITH THE FOLLOWING INFORMATION: (LOCATION OPTIONAL, EXCEPT MARKING SHALL NOT BE VISIBLE WHEN INSTALLED IN BASE.)
 (REFERENCE 10481 ORIENTATION)
 A) KORRY CAP ASSEMBLY PART NUMBER
 B) "KORRY"
 C) SOURCE CODE
 D) DATE CODE

4. SWITCH ACTION:
 A) ALTERNATE: WHEN ACTUATED BY DEPRESSING CAP, SWITCH CONTACTS ARE MAINTAINED UNTIL ACTUATED AGAIN.
 B) MOMENTARY: WHEN ACTUATED BY DEPRESSING CAP, SWITCH CONTACTS ARE MAINTAINED UNTIL CAP IS RELEASED.

5. SUBMINIATURE SWITCH CONTACT MATERIAL / RATING:
 A) GOLD, 1 AMPERE AT 28 VOLTS DC (RESISTIVE LOAD)
 B) SILVER, 7 AMPERES AT 28 VOLTS DC (RESISTIVE LOAD)

6. CHARACTER TYPE:
 - GORTON CONDENSED

7. MOUNTING LUG LOCATION SHOWN FOR REFERENCE.

8. MOUNTING ASSEMBLY, WHEN ORDERED SEPARATELY, SHALL BE BAGGED AND TAGGED WITH THE FOLLOWING INFORMATION:
 A) KORRY PART NUMBER

REVISIONS				
ZONE	LTR	DESCRIPTION	DATE (YR-MO-DA)	APPROVED
A		INCORP. KCRM 83325.	CLA 99-06-24	S. Hansen 99/06/30

UNINCORPORATED
CHANGES ARE ATTACHED
TO THIS DRAWING

SEE SEPARATE PARTS LIST

REV STATUS OF SHEETS	REV	A	A	A	A	A	A	A	A	A										
SHEET	1	2	3	4	5	6	7	8	9											
CONTRACT NUMBER		QUICK SWITCH										DESIGN ACTIVITY								
CONTRACTOR		DRAWN BY C. ANDERSON										DATE (YR-MO-DA) 96-12-09								
DRAWN BY		CHECKER S. HANSEN										ENGINEER B. BAKKER								
DRAWING APPROVAL (PROJ MGR) BRYAN BAKKER 3/14/97		DESIGN APPROVAL (OSGN ENGR MGR) MIKE GROVER 3/14/97										TITLE SWITCH ASSEMBLY, LIGHTED, 428								
SIZE	CAGE CODE	DRAWING NO										REV								
C	81590	20695										A								
SCALE	NONE	UNIT WEIGHT	SHEET 1 OF 9																	

PNIC	428	UNLESS OTHERWISE SPECIFIED DIMENSIONS ARE IN INCHES	
TOLERANCES ON		2 PLACE	3 PLACE
		± .03	± .005
MATERIAL		---	
FINISH		---	
WALL ENGR	MFG ENGR	QUAL ENGR	
	J. FRYE	J. HAND	
DATABASE AND USER		LAYOUT	NEXT ASSY
CAD INFORMATION		APPLICATION	

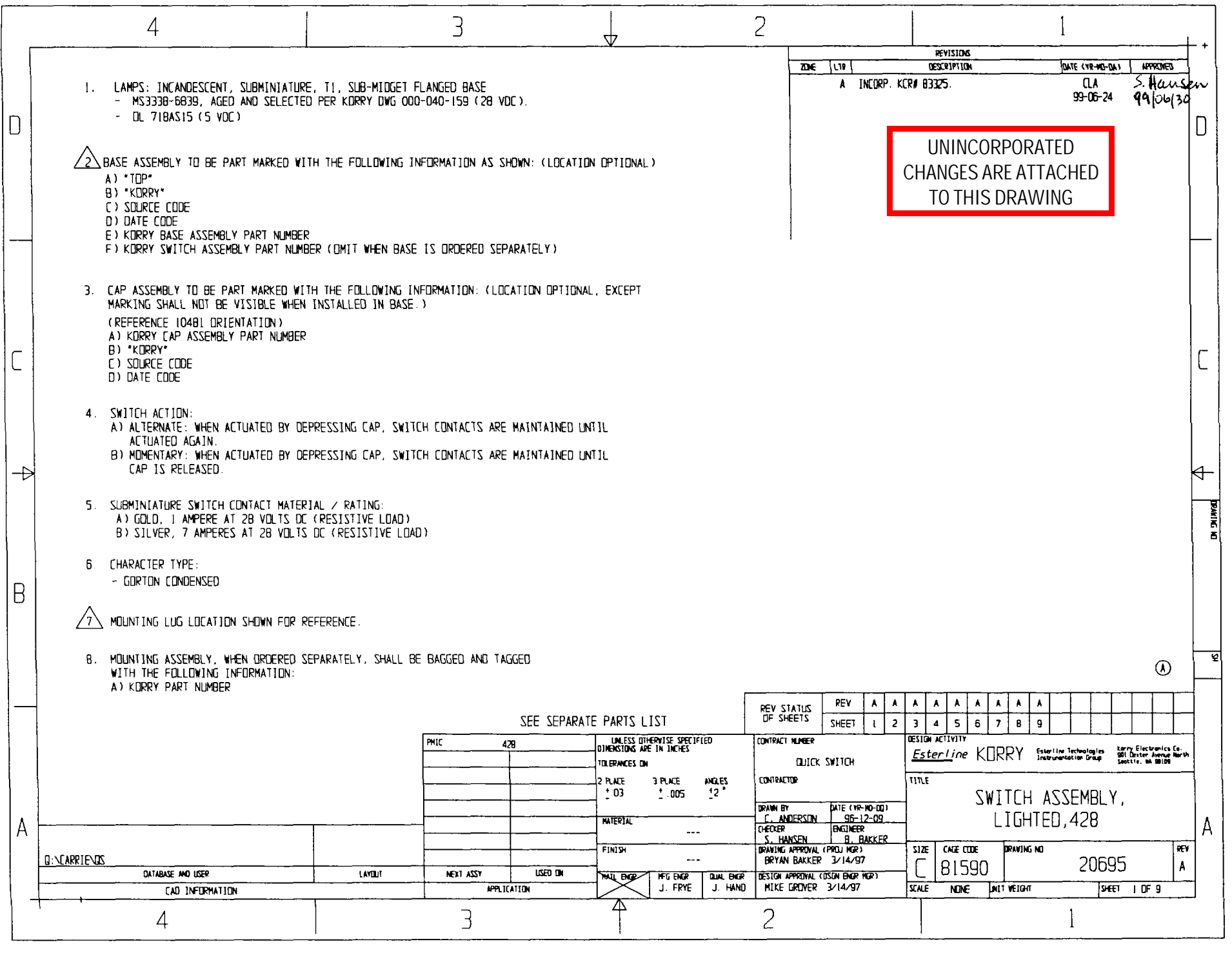

4

3

2

1

ORG. NO. SH REV

REVISIONS			
ZONE	LTR	DESCRIPTION	DATE/NO-DAY APPROVED

LEGEND TYPES	
1B	LEGEND NOT VISIBLE UNTIL ILLUMINATED; LIGHTED LETTERS ON OPAQUE BLACK BACKGROUND. (HIDDEN LEGEND)
1C	LEGEND NOT VISIBLE UNTIL ILLUMINATED; LIGHTED BACKGROUND WITH OPAQUE LETTERS. (HIDDEN LEGEND)
2F	OPAQUE WHITE LETTERS VISIBLE AT ALL TIMES ON DARK BACKGROUND. BACKGROUND WHEN ILLUMINATED SHOWS COLOR.
2G2	WHITE LETTERS VISIBLE AT ALL TIMES ON OPAQUE BLACK BACKGROUND. LETTERS WHEN ILLUMINATED SHOW COLOR.

TABLE 1
LEGEND TYPES

Ⓐ

Ⓐ

D

D

C

C

B

B

A

A

4

3

2

1

DATABASE AND USER		LAYOUT	SIZE C	CAGE CODE 81590	ORG NO 20695	REV A
CAD INFORMATION			SCALE NONE	SHEET 2		

4

3

2

1

DWG. NO.		SH.	REV.	1
REVISIONS				
ZONE	LTR	DESCRIPTION	DATE (YR-MO-DA)	APPROVED

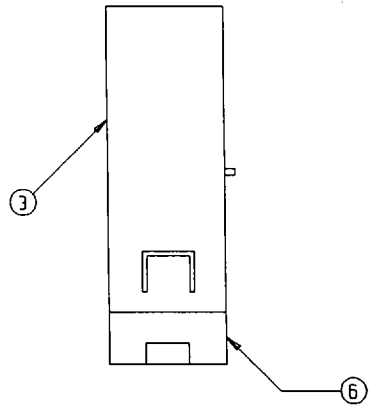
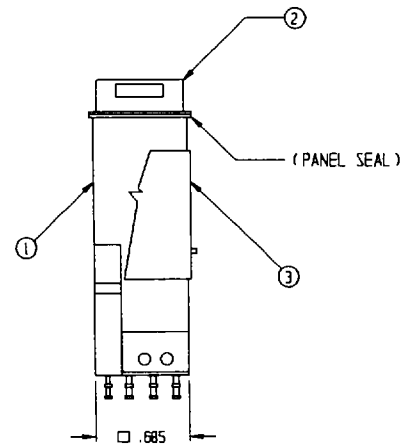
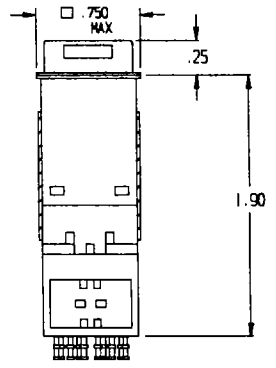
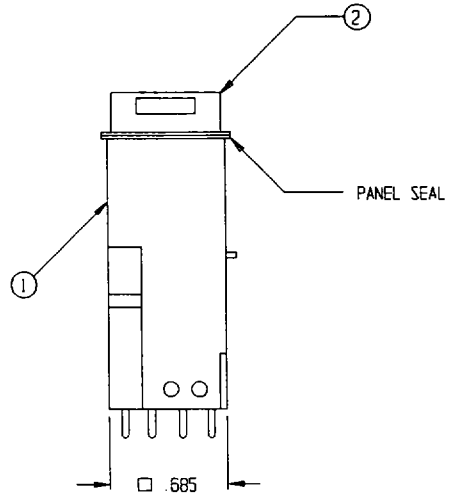
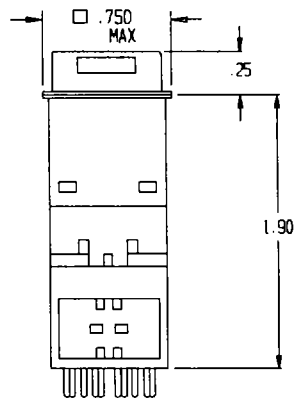

POKEHOME (22 AWG)
TYPE 1

Ⓐ

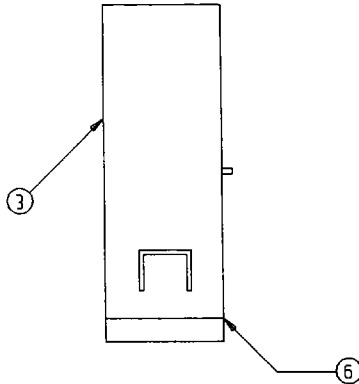

POKEHOME (20 AWG)
TYPE 2

Ⓐ

SWITCH CONFIGURATION

SWITCH CONFIGURATION (T-2)
TYPE 3
Ⓐ

DATABASE AND USER		LAYOUT	SIZE C	FACE CODE B1590	DWG NO 20695	REV A
CAD INFORMATION			SCALE NONE	SHEET 3		

4

3

2

1

4

3

2

1

DWG. NO.		SH.	REV.	1	
REVISIONS					
ZONE	LTR	DESCRIPTION	DATE (YR-MO-DAY)	APPROVED	

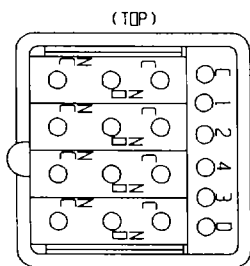
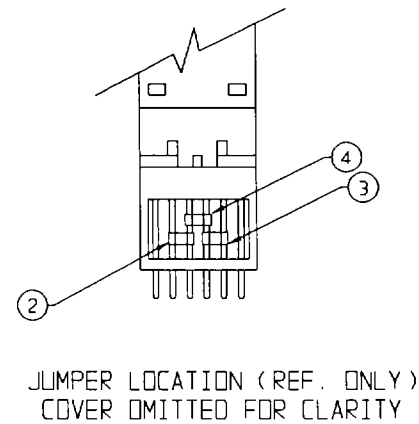
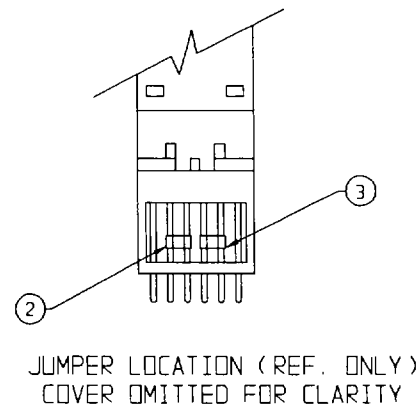
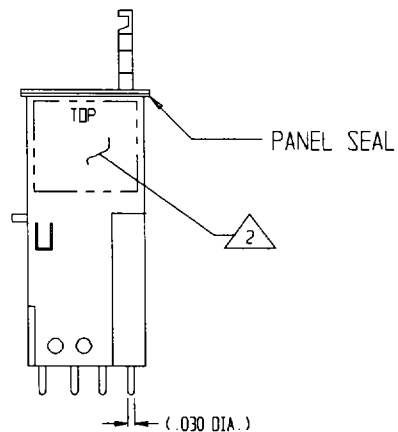
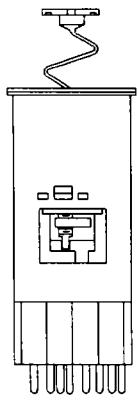

SCALE : 4/1

①
 FIGURE 1
 BASE ASSEMBLIES (22 PKH)
 20695-()

DRAWN AND USER		LAYOUT	SIZE C	CAGE CODE 81590	DWG NO 20695	REV A
CAD INFORMATION			SCALE NONE	SHEET 4		

4

3

2

1

4

3

2

1

DWG. NO.

SH.

REV.

REVISIONS			
ZONE	LTR	DESCRIPTION	APPROVED
		018119-00-0A1	

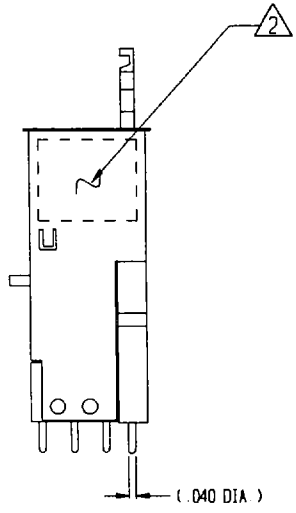
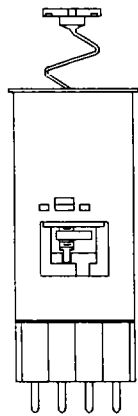

SCALE 2/1

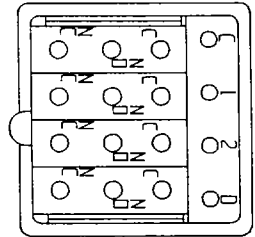

①
 FIGURE 2
 BASE ASSEMBLIES (20 PKH)
 20695-()

DATABASE AND USER

LAYOUT

SIZE CASE CODE 81590

DWG NO 20695

REV A

CAD INFORMATION

SCALE NONE

SHEET 5

4

3

2

1

D
C
B
A

D
C
B
A

DNG. NO.		SH.	REV.	1	
ZONE		LTR	DESCRIPTION	DATE (YY-MM-DD)	APPROVED

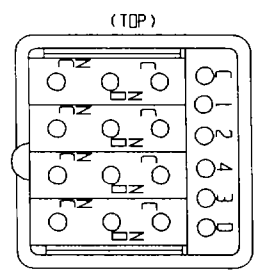
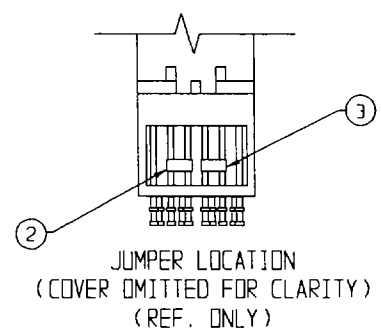
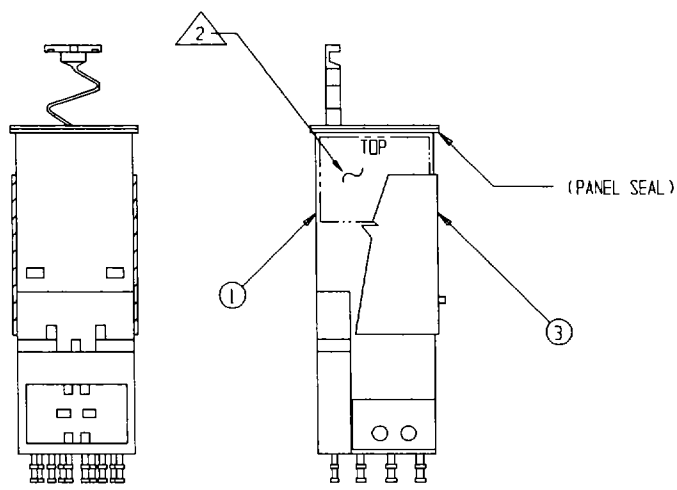

SCALE : 4/1

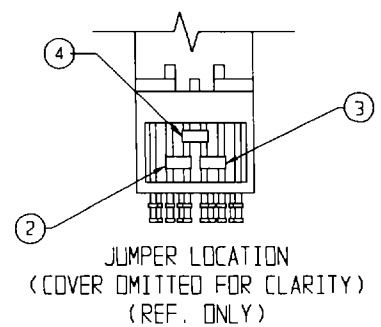

Ⓐ
 FIGURE 3
 BASE ASSEMBLIES (T-2)
 20695-()

DATABASE AND USER		LAYOUT	SIZE C	CAGE CODE 81590	DWG NO 20695	REV A
CAD INFORMATION			SCALE NONE		SHEET 6	

4

3

2

1

DWG. NO.		SH.	REV.
REVISIONS			
ZONE	LTP	DESCRIPTION	(DATE/HP-NO-DA)
			APPROVED

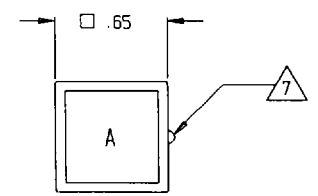
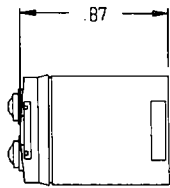

CAP CONFIGURATION
TYPE 1

(A)

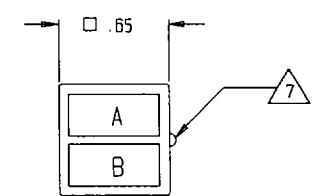

CAP CONFIGURATION
TYPE 2

(A)

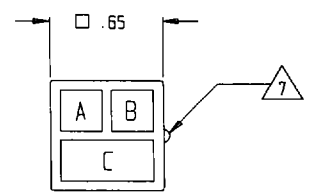

CAP CONFIGURATION
TYPE 3

(A)

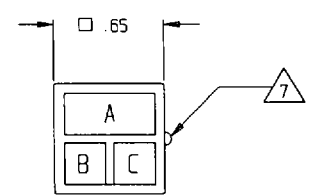

CAP CONFIGURATION
TYPE 4

(A)

CAP ASSEMBLIES
20695-()

DATABASE AND USER		LAYOUT	SIZE C	CAGE CODE 81590	DWG NO 20695	REV A
CAD INFORMATION			SCALE NONE		SHEET 7	

4

3

2

1

4

3

2

1

DWG. NO. SH. REV.

REVISIONS			
ZONE	LTR	DESCRIPTION	DATE
			01/18/90-DA-1
			APPROVED

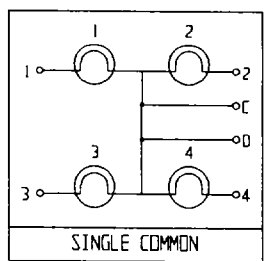

LAMP CIRCUIT TYPE 1

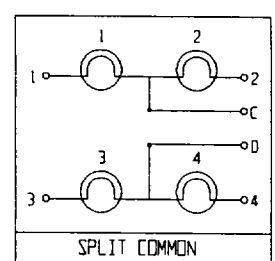

LAMP CIRCUIT TYPE 2

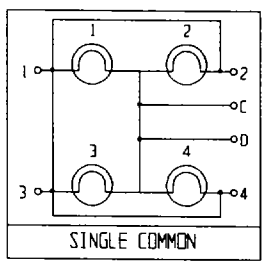

LAMP CIRCUIT TYPE 3

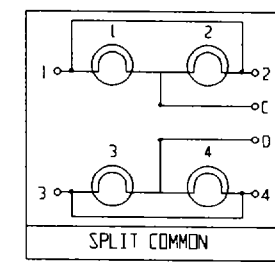

LAMP CIRCUIT TYPE 4

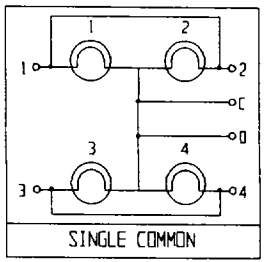

LAMP CIRCUIT TYPE 5

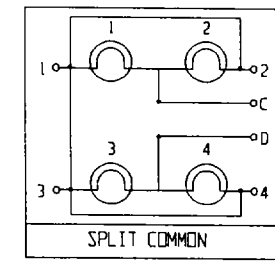

LAMP CIRCUIT TYPE 6

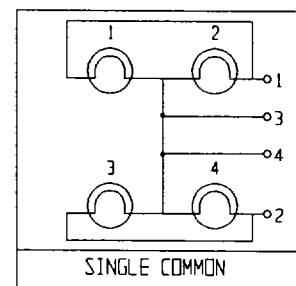

LAMP CIRCUIT TYPE 7

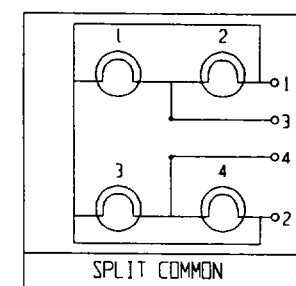

LAMP CIRCUIT TYPE 8

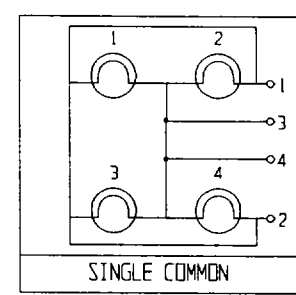

LAMP CIRCUIT TYPE 9

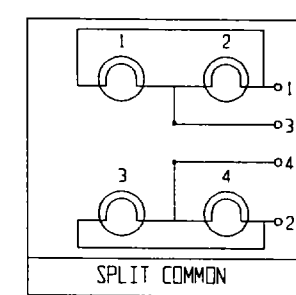

LAMP CIRCUIT TYPE 10

22 GAUGE

20 GAUGE

(A)

DATE/ISSUE AND USER	LAYOUT	SIZE C	CAGE CODE B1590	DWG NO 20695	REV A
CAD INFORMATION		SCALE NONE	SHEET B		

4

3

2

1

4

3

2

1

DWG. NO.		SH.	REV.	1
REVISIONS				
ZONE	LTR	DESCRIPTION	DATE (YR-MO-DA)	APPROVED

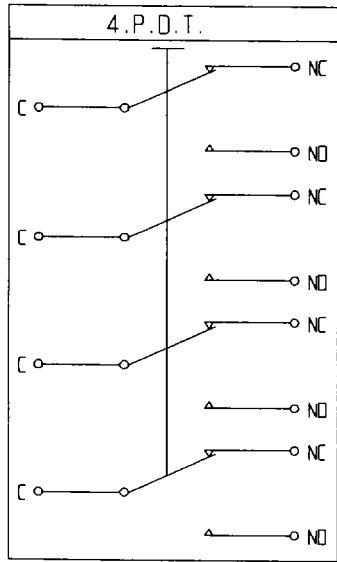

TYPE 1
Ⓐ

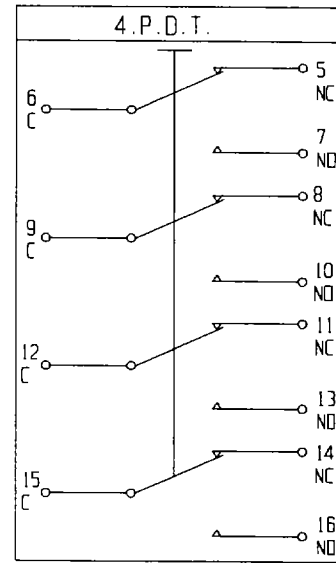

TYPE 2
Ⓐ

SWITCH CIRCUITS

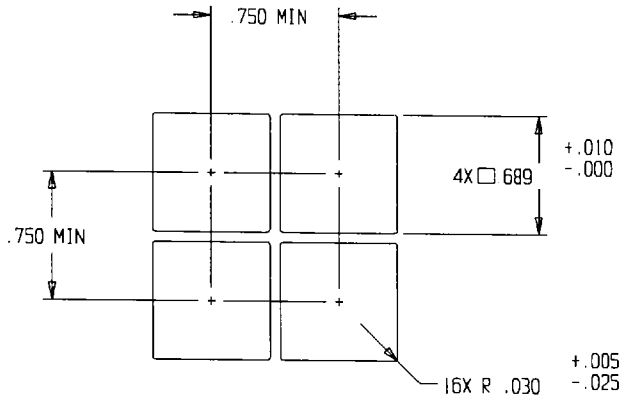

RECOMMENDED
PANEL CUTOUTS

DATABASE AND USER	LAYOUT	SIZE C	CAGE CODE B1590	DWG NO 20695	REV A
CAD INFORMATION		SCALE NONE	SHEET 9		

4

3

2

1